

# SCM and SCM-DH

## Single Column Mixing

*Methods*





## Advantages of the SCM and SCM-DH techniques



Mixing of self-hardening slurry with natural or backfilled soil by means of the SCM technique has long been established in many parts of the world.

The SCM-DH technique is a development of the SCM technique and extends the application to cohesive soils and larger column diameters.

The techniques are economical construction processes for the construction of columns and walls as foundation elements and for soil improvement.

#### Areas of application:

- Foundations
- Soil improvement
- Slope stabilization
- Prevention of soil liquefaction
- Retaining and cut-off walls

### **Natural soil is used as construction material**

The natural soil is mixed with a self-hardening slurry. As a result, most of the soil remains in the soil mix element and is used as construction material.

### **Minimum of excavated material**

Due to the use of the natural soil as a construction material, only part of the natural soil has to be disposed of. This advantage applies in particular to contaminated soils. (This advantage is particularly important for contaminated soils). The amount of soil material to be disposed of is dependent on various local factors and usually varies between 15 and 50 % of the column volume.

### **Vibration-free construction process**

Mixing the soil with the self-hardening suspension does not cause any vibrations in adjoining buildings. This means that it is possible to construct single soil mixing columns close to sensitive buildings.

### **No ready-mixed concrete supplies required**

As a rule, the self-hardening slurry to be introduced is mixed on site as required. This means that the supply of fresh concrete is not required, which can be an advantage particularly in remote or poorly accessible areas and also in inner city areas.

### **The slurry exits the mixing tool at low pressure**

Compared to other methods, such as jet grouting, the slurry exits the mixing tool at a very low pressure. Sensitive structures, such as pipelines, buildings or tunnels in the vicinity of the column are, therefore, not at risk from slurry under high pressure. This also ensures that the slurry pressure does not influence the diameter of the column. As a rule, slurry pumps with a maximum delivery pressure of around 10 to 20 bar are deployed.



## Working sequence

### Preparation:

Depending on the local soil conditions, it is recommended to excavate a pre-excitation trench to take up the backflow.

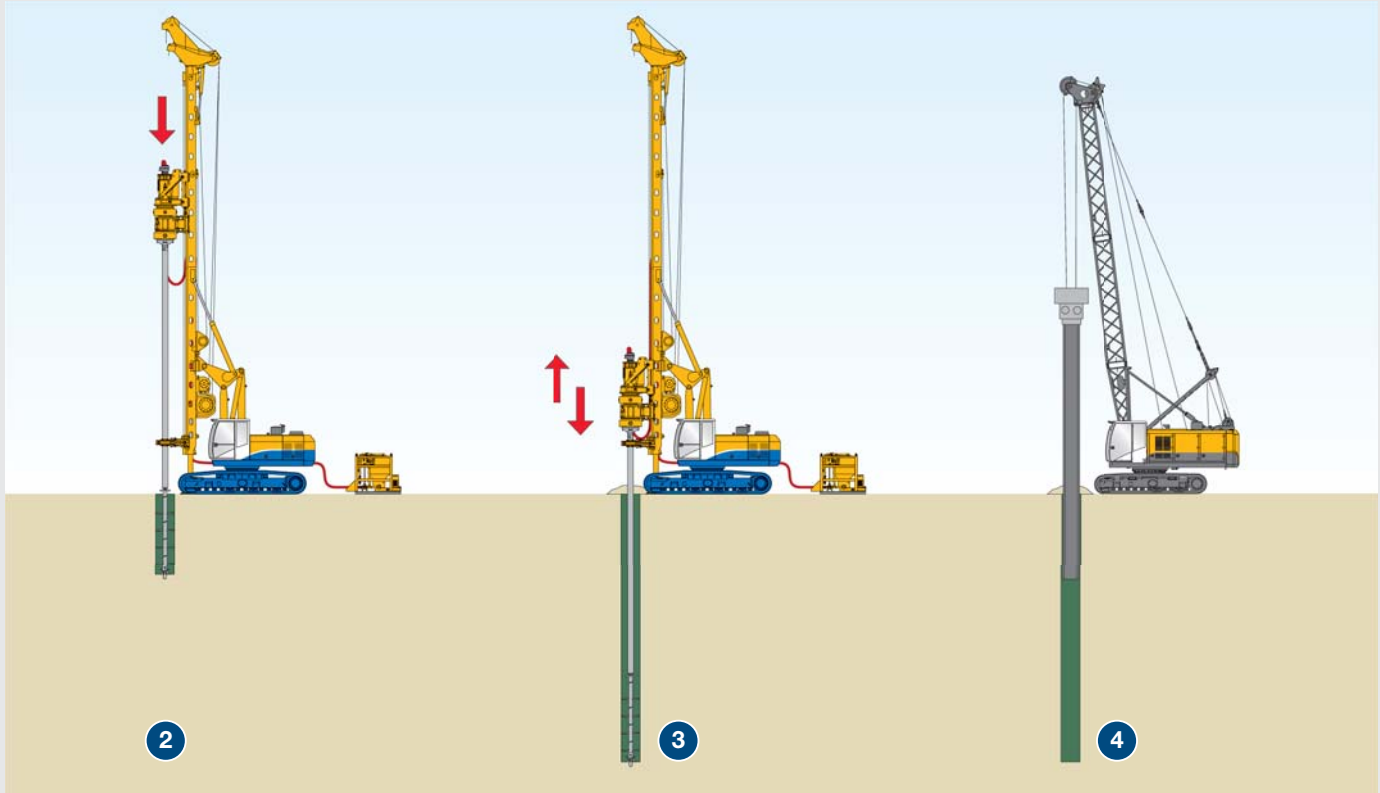

### Step 1:

Set up the mixing tool at the required working position.

### Step 2:

The mixing tool is continuously rotated into the ground while simultaneously adding the required slurry. The speed at which the mixing tool is advanced and the rate at which the slurry is pumped are controlled in such a way that as little excess slurry as possible returns to the surface.

### Step 3:

After the final depth has been reached, the mixing tool is withdrawn from the ground while continuing to rotate. Depending on the type of soil, repeated insertion and withdrawal of the mixing tool can improve the mixing result.

### Step 4:

Depending on structural requirements, reinforcing elements, such as steel stanchion, can be inserted into the fully mixed, but not yet hardened column.

### Constructing a continuous wall:

To construct a continuous wall, individual SCM columns are installed in an alternating construction sequence. Neighbouring primary columns are preferably overlapped "fresh-in-fresh" immediately after completion by secondary columns.



*P = Primary column*

*S = Secondary column*

## Productivity factors

The average properties that can be achieved depend, among other things, on the following boundary conditions:

	Favourable conditions	Unfavourable conditions
Soil structure	Uniform structure	Layered soil formation (alternating sequence)
Soil type	Loose to medium dense gravelly sand, silty sand	Dense soil formation, stones, hard cohesive soil, organic soil (reduction in the final strength)
Construction site geometry	Long, straight rows of columns	Angled wall layout
Column depth	Column depth > 10 meters	Column depth < 10 meters (influence of unproductive time, such as repositioning and setting up)

## Slurry specifications

### Components:

- The slurry used for the construction of SCM columns usually consists of cement (Portland cement or blast furnace cement CEM III/B 32.5) and water. Additives such as fly ash and bentonite, as well as admixtures (plasticiser, retarder) can be added.

### Wall properties:

		Cut-off wall	Supporting column
Compressive strength $q_u$	N/mm <sup>2</sup>	0.5 - 2	2.5 - 15
Water permeability $k_f$	m/s	approx. $1 \times 10^{-8}$	
Cement/soil	kg/m <sup>3</sup>	100 - 200	200 - 500

### Mix ratio:

- Selection of the slurry mix ratio is to be determined – especially in the case of unfamiliar soils – by a suitability test prior to starting work on site. The following figures are approximate guide values.

### Binder slurry (typical guide values):

		Cut-off wall	Supporting column
Cement/slurry	kg/m <sup>3</sup>	250 - 450	500 - 1,200
Bentonite/ (optional) slurry	kg/m <sup>3</sup>	30 - 50	0 - 30
w/c ratio		2.0 - 4.0	0.5 - 1.5

The mix design and the column properties depend very much on the following factors:

### Application:

- Cut-off wall (permeability, strength, plasticity, erosion resistance)
- Supporting column or retaining wall (strength, permeability, plasticity of the fresh mix as a precondition for the installation of reinforcement)

### Soil conditions:

The suitability of the system and the characteristics of the final product depend on the following criteria: grain distribution, grain size, fines content, organic matter, density, voids ratio, groundwater conditions, chemical impurities.

## Range of application

The following table provides a rough indication of the range of application. This table serves only as an initial assessment.

For a more detailed assessment, please contact the BMA Process Development Department.

Soil mixing technique	Clay		Silt		Sand/Gravel *		Rock **	
	pasty	→ very hard	pasty	→ very hard	very loose	→ extremely dense	very soft	→ moderately hard
SCM	[Yellow to Red]		[Yellow to Red]		[Green to Yellow]		[Red]	
SCM-DH	[Yellow]		[Green]		[Green]		[Red]	
SMW	[Red]		[Yellow to Red]		[Green to Yellow]		[Red]	
CSM	[Green]		[Green]		[Green]		[Red] ***	

\* Rock strengths according to the Geological Society 1970

\*\* Only recommended for thin layer thicknesses or rock sockets up to max. 2 m





## SCM Tool

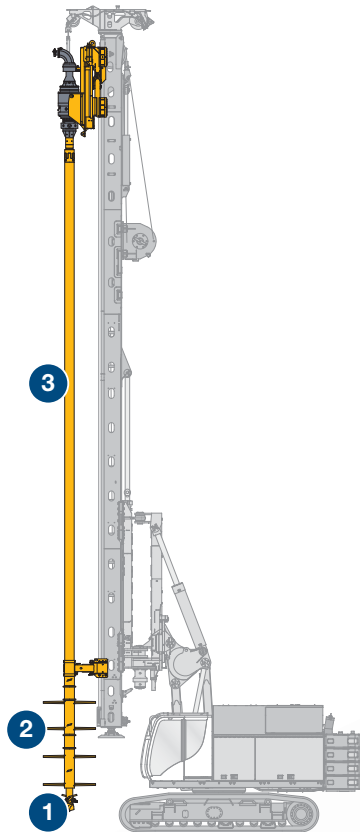

The SCM tool is available for column mix diameters between 600 and 2,400 mm. The SCM drill string consists of three sections:

- 1 The soil is loosened by two blades equipped with tangentially cutting flat teeth and a centrally mounted pilot bit. During the cutting process, slurry is continuously introduced into the loosened soil via slurry nozzles extending radially from the center in order to liquefy, stabilize, and subsequently bind the soil.
- 2 Above the starter auger is the actual mixing zone. The mixing paddles produce a fully homogenized mixture of the soil with the slurry.
- 3 The drill string finishes with a simple drill string extension. This ensures reaching the required depth of the column without generating friction over the entire length.

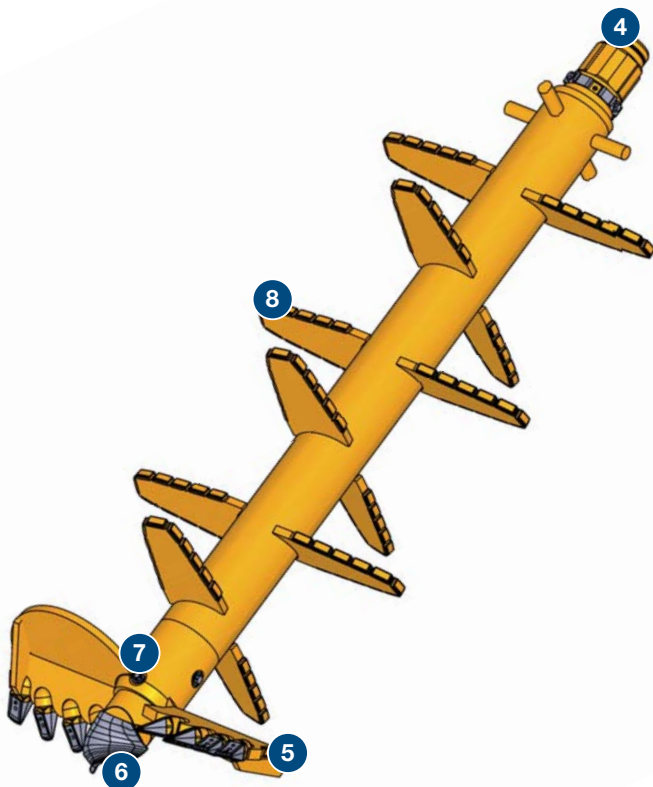

- 4 Joint for connecting the mixing tool to the drill string extension.
- 5 Cutting blades equipped with flat teeth – depending on the prevailing soil conditions, different flat teeth can be used.
- 6 Pilot bit which is easily replaced.
- 7 Slurry ports – inserts can be used to adjust the aperture diameter of the slurry nozzles to local conditions.
- 8 Mixing paddles – large number of mixing paddles for thoroughly breaking up and mixing the soil with the injected binder slurry.

## Machines for the SCM method

The standard SCM method can be carried out by a variety of BAUER BG PremiumLine and RTG rotary drilling rigs. The achievable mixing depths depend on the base machine used.

By using mast extensions, Kelly extensions or even lattice mast extensions, an increase in the mixing depth can be achieved.

Examples of RTG RGs and BAUER BGs for the SCM method without installation of drill string extensions:

Machine type	Base machine	Rotary drive	Option BTM 200	Mixing diameter [mm] max.	Max. mixing depth [m] **	
					Standard mast	Lattice mast extension
BG 15 H	BT 40	KDK 150	x	1,500	11.2	-
BG 20 H	BT 60	KDK 200	x	1,500	14.1	24.6
BG 24 H	BT 75 / BT 85	KDK 280	x	2,500 *	17.0	30.0
BG 28 H	BT 85	KDK 300	-	2,500 *	19.2	31.5
BG 34 H	BS 95	KDK 340	-	2,500 *	18.6	31.6
BG 34	BS 95	KDK 340	-	2,500 *	21.3	34.3
BG 39	BS 95	KDK 390	-	3,700 *	23.7	40.2
BG 46	BS 115	KDK 550	-	3,700 *	25.5	-
RG 16 T		MB	-	2,000 *	15.5	-
RG 21 T		MB	-	2,000 *	20.5	-
RG 18 S		MB / KDK	-	2,000 *	17.1	-
RG 25 S		MB / KDK	-	2,000 *	24.5	-

\* Maximum mixing diameter must be checked with reference to other factors

\*\* Combination of maximum diameter and maximum depth must be adjusted if necessary



BG 24 H with KDK and BTM 200



RG 21 T with MB 155-F



RG 25 S with Kelly extension

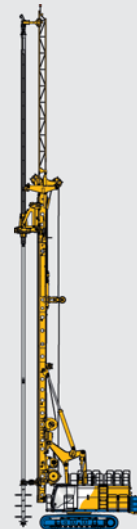

BG 30 with lattice mast extension

Greater mixing depths than indicated in the table above can be achieved by the installation of additional drill string extensions (addition of drill string sections) during construction of the SCM column.

This has already resulted in mixing depths of about 50 meters having been achieved, for example, with RTG RG 25 S and BG 34 H drilling rigs.



## Rotary drives for the SCM method

Various rotary drives are currently available for the SCM method. When using RTG RGs as base machines, MB 55-F, MB 75-F or MB 155-F rotary drives are generally used. The rotary drives of the MB series are specially designed for the high hydraulic power of the RG machines.

When using BAUER BGs of the PremiumLine as base machines, standard KDKs are used – optionally with the BTM 200 torque multiplier. The BTM 200 torque multiplier is used with the SCM technique to increase the speed of the mixing tool.

### Examples of possible rotary drives:

	MB 55-F	MB 75-F	MB 155-F	KDK	KDK with BTM 200
Torque (max.) [kNm]	56	74	150	*	100 **
Speed (max.) [U/min.]	85	64	69	54 **	90 **
Kelly extension possible	-	-	-	+	-

\* The torque is limited to the maximum permitted torque of the drill string or tool

\*\* Actual values depend on the KDK used

## Auxiliary equipment

Recommended auxiliary equipment to facilitate an efficient work process.

### Slurry mixing station

- Mixing capacity between 15 and 40 m<sup>3</sup>/h

### Delivery pump

- Frequency-controlled pump with remote control; capacity depends on the volume of the column and on the mixing speed (typically 200 - 600 l/min at 12 - 15 bar)

### Agitation tank

- Approx. 3 - 6 m<sup>3</sup> (as buffer capacity for binder slurry)

### Silos

- For cement (with screw conveyors), optional additional bentonite silo

### Mini-excavator

- For maintenance of the working platform and handling of the return flow

### Hoses

- For conveyance of slurry from the agitation tank to the SCM rig (typically: 1.5" - 2.5" mud hose)

MAT SCA-15K compact mixer including pump and agitation tank







## SCM-DH Tool

The newly developed SCM-DH tool (Single Column Mixing tool for Double Head rotary drives) represents a significant improvement of the single column mixing tool that has proved itself over many years and is well-established worldwide. Due to the two counter-rotating mixing tool components, more intense mixing and homogenization of the soil with the slurry can be achieved. This makes the tool suitable for the construction of soil mixing columns not only in sandy but also in cohesive soils.

The tool is designed in such a way that, when DKS or BG rotary drives are employed with additional torque converter, the higher torque is used for loosening and breaking up the soil whilst the faster rotating inner drill string simultaneously achieves a particularly intensive mixing of the soil with the slurry. The SCM-DH mixing tool is available in the standard sizes 1,800 mm, 2,100 mm and 2,400 mm. The counter-rotations generated by the double head rotary drive are transmitted to the tool by the outer and the inner tube.

- 1 Blades equipped with flat teeth – depending on the local soil conditions, different flat teeth can be used.
- 2 Slurry nozzles – diameter and number of nozzles can be quickly adapted to prevailing local conditions.
- 3 Pilot is easily replaced.

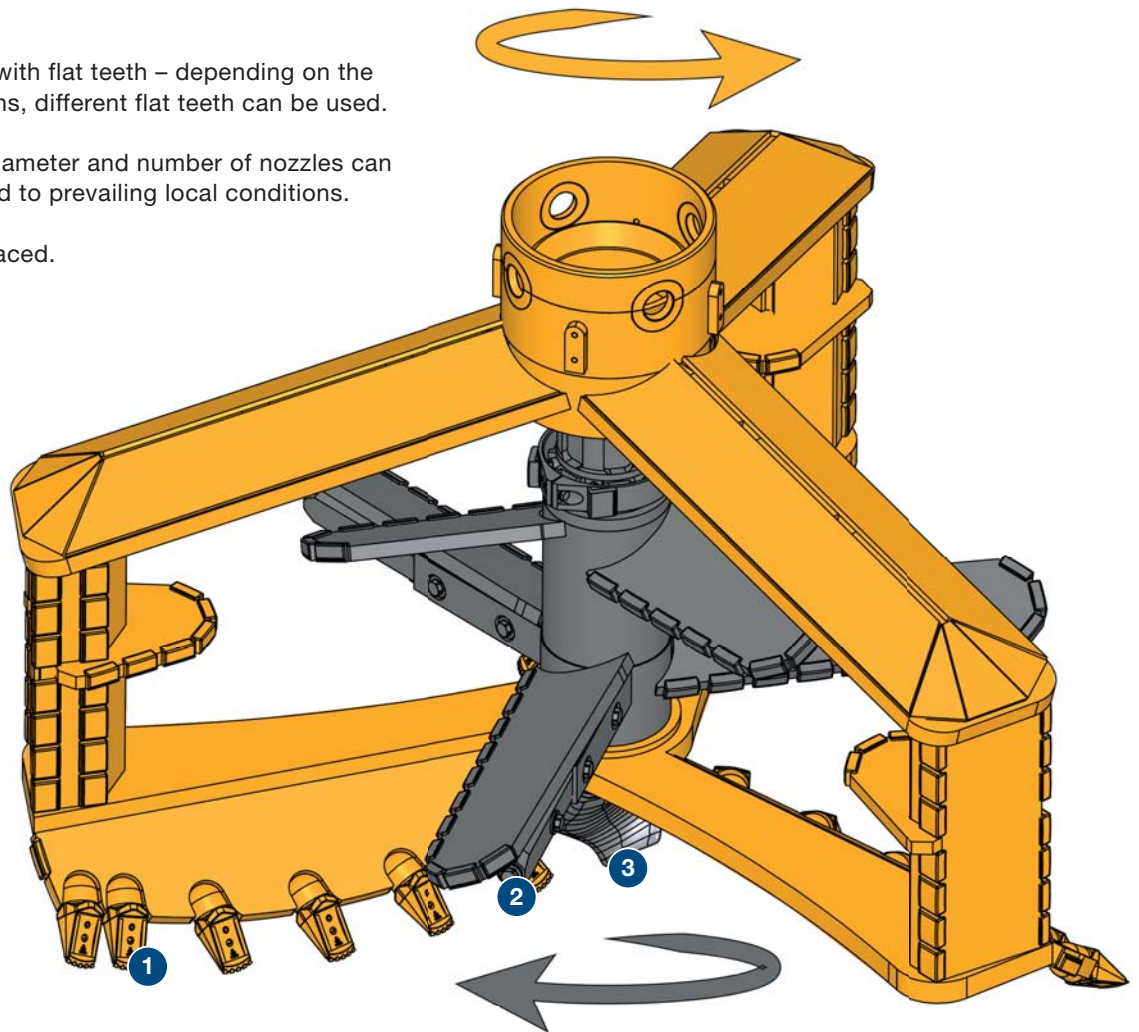

A “clay package” (not shown in the above figure) can be used to adapt the tool for use in highly cohesive soils to further intensify the mixing process of the soil.



## Machines for the SCM-DH method

Due to the minimum mixing diameter of 1,800 mm, the SCM-DH technique requires a base machine with a higher hydraulic power output compared to the standard SCM method. For this reason, the RTG RGs or the larger BGs

are more suitable for this technique. Since Kelly extensions cannot be used with this technique, the maximum penetration depth is largely dependent on the base machine.

### Examples of RTG RGs and BAUER BGs for the SCM-DH method:

Machine type	Base machine	Rotary drive	Mixing diameter [mm] max.	Max. mixing depth [m] ** with BTM 400	Max. mixing depth [m] ** with DKS
BG 24 H	BT 75 / BT 85	KDK + BTM 200 / DKS 50/140	1,800 *	16.4	17.3
BG 28 H	BT 85	KDK + BTM 400 / DKS 50/140	2,400 *	18.5	19.7
BG 34 H	BS 95	KDK + BTM 400 / DKS 100/200	2,400 *	18.5	19.7
BG 34	BS 95	KDK + BTM 400 / DKS 100/200	2,400 *	21.0	21.7
BG 39	BS 95	KDK + BTM 400 / DKS 100/200	2,400 *	22.9	23.6
BG 46	BS 115	KDK + BTM 400 / DKS 150/300	2,400 *	24.1	24.9
RG 16 T		DKS	1,800 *	-	15.5
RG 21 T		DKS	1,800 *	-	20.5
RG 18 S		DKS	2,400 *	-	17.1
RG 25 S		DKS	2,400 *	-	24.5

\* Maximum mixing diameter must be checked with reference to other factors

\*\* Combination of maximum diameter and maximum depth must be adjusted if necessary

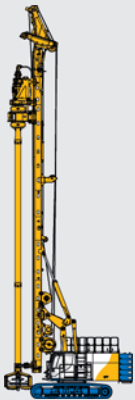

BG 28 H (BT 85)  
with KDK + BTM 400



RG 21 T  
with DKS 50/100

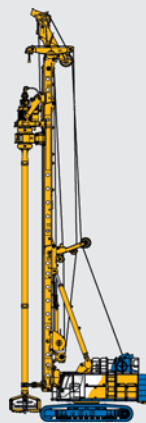

BG 39  
with DKS 100/200







RG 25 S  
with DKS 100/200

## Rotary drives for the SCM-DH method

Various rotary drives are currently available for the SCM-DH method. When using RTG RGs as base machines, DKS rotary drives are used, such as DKS 50/100, DKS 100/200-02 and DKS 150/300. One of the advantages of DKS rotary drives is their ability to rotate the inner and outer mixing tools independently of each other. As a result, the inner

mixing tool can be operated at a high rotational speed even if the outer mixing tool has a high torque requirement (loosening harder soil layers). When using BAUER BGs of the PremiumLine as base machines, standard KDKs with a BTM 200 or BTM 400 torque multiplier are generally used. DKS drives can also be used with the BGs.

### Examples of possible rotary drives:

	DKS 50/100	DKS 100/200-02	DKS 150/300	KDK with BTM 200	KDK with BTM 400
					
Torque (max.) [kNm]	50/100 *	100/200	152/274	150/300 **/****	150/300 **/****
Speed inner/outer (max.) [rpm]	65/39	40/20	29/22	44/22 ***	50/25 ***

\* For RTG RGs with telescopic leader the maximum outer torque is 80 kNm

\*\* The torque is limited to the maximum permitted torque of the drill string or tool

\*\*\* Actual values depend on the KDK used

## Auxiliary equipment

Recommended auxiliary equipment to facilitate an efficient work process.

### Slurry mixing station

- Mixing capacity between 30 and 80 m<sup>3</sup>/h

### Delivery pumps

- Frequency-controlled pumps with remote control; total capacity depends on the volume of the column and on the mixing speed (typically 500 - 1500 l/min at 12 - 15 bar)

### Agitator tank

- Approx. 4 - 12 m<sup>3</sup> (as buffer capacity for binder slurry)

### Silos

- For cement (with screw conveyors), optional additional bentonite silos

### Mini-excavator

- For maintenance of the working platform and handling of the return flow

### Hoses

- For conveyance of slurry from the agitation tank to the SCM-DH rig (typically: 2" - 2.5" mud hoses)



2 x MAT SCC-30 compact mixing plant, delivery pumps, agitation tank, water tank

## Control of production parameters (on rig operator's monitor)

The electronic control and monitoring system – B-Tronic – can be installed in all SCM rigs. This data acquisition system monitors and controls both production parameters and general machine operating data.

The following production parameters can be continuously recorded, visualized and stored:

- Depth
- Slurry volume
- Slurry pressure in pipeline
- Pump volume / unit of time
- Pump volume / unit of depth
- Speed of the mixing tool
- General machine operating parameters

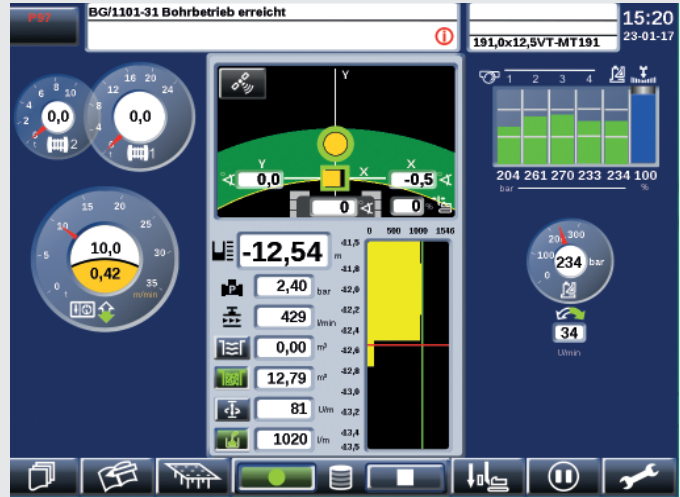

Display of production-relevant data in the B-Tronic

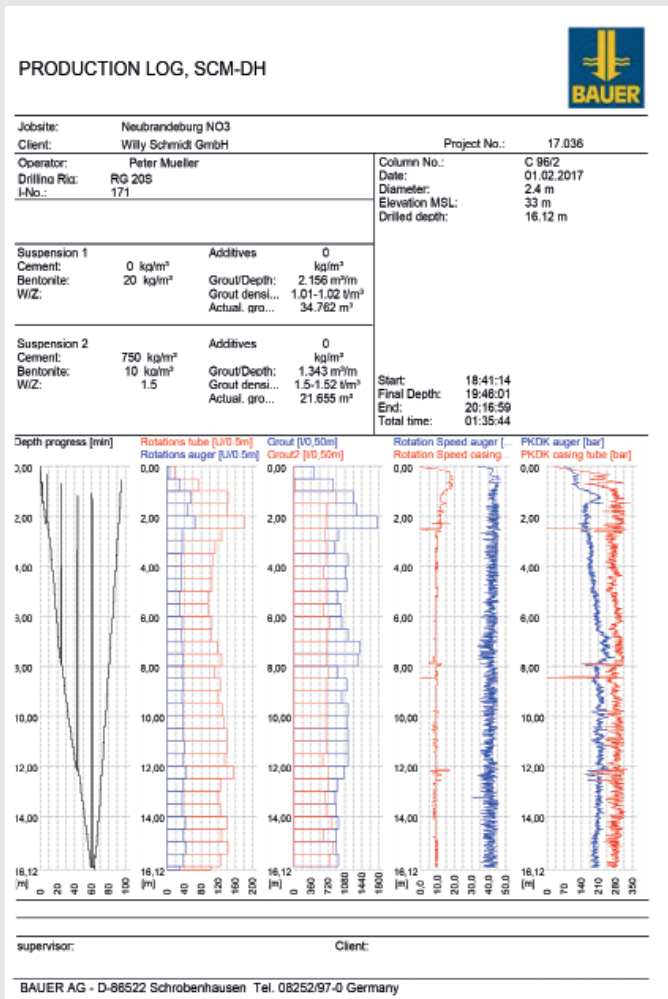

Example of a production log, generated by the B-Report software

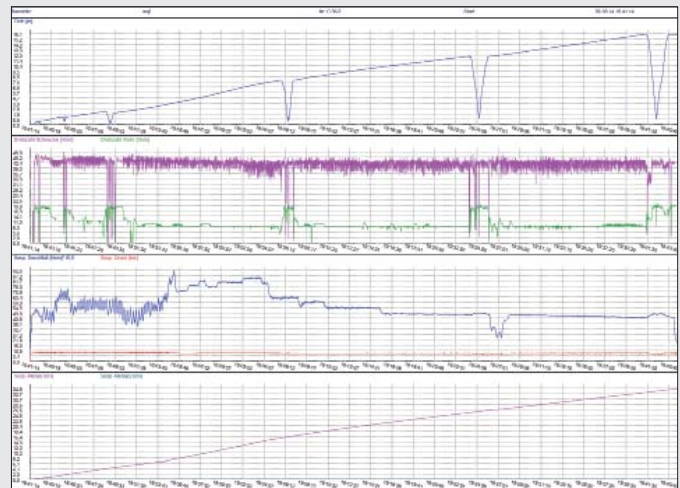

Display of the production data in the B-Report software

## Documentation

All production data is recorded and stored in the machine during production. This data can be printed for each column as a quality report.



### **In-situ samples of soil mix material**

The quality control of the finished soil mix elements is carried out on samples taken either before or after hardening of the soil slurry mix.

Sampling before hardening can be carried out with a sampling tool. For this purpose, a relatively pasty or liquid consistency of the freshly mixed soil is required.



*Removal of fresh samples with a sampling tool*



*Cut-open inner plastic tube with hardened core*

**Sampling after hardening** can, for example, be carried out by:

- Extraction of 'horizontal' cores with hand drills
- Extraction of 'vertical' cores with drill rigs used for exploratory boreholes
- Inserting a set of double-walled plastic tubes into the fresh soil mix element and extracting the inner plastic tube after hardening complete with the hardened core inside the tube



*Vertical core drilling with a drill rig for exploratory boreholes*





## Methods



[bma.bauer.de](http://bma.bauer.de)



**BAUER Maschinen GmbH**  
**BAUER-Strasse 1**  
**86529 Schrobenhausen**  
**Germany**  
**Tel. +49 8252 97-0**  
**[bma@bauer.de](mailto:bma@bauer.de)**  
**[www.bauer.de](http://www.bauer.de)**

Design developments and process improvements may require the specification and materials to be updated and changed without prior notice or liability. Illustrations may include optional equipment and not show all possible configurations. These and the technical data are provided as indicative information only, with any errors and misprints reserved.